.....	1
.....	1
.....	2
.....	3
.....	4
.....	5
.....	5
.....	7
.....	7
.....	10



PC



1.

()	
LOCK	
ACC	
ON	
PH	()
START	ON

2.

(a).

(b).

3.

	1. ()	
	2. ()	
	3. ()	
	4. ()	
	5. ()	
	6. ()	
	7. ()	
	1. ()	
	2. ()	
	3. ()	
	4. ()	
	5. ()	
	1. ()	
	2. ()	
	1. ()	
	2. ()	
	3. ()	
	4. ()	
	5. ()	



1	
2	

3	
---	--

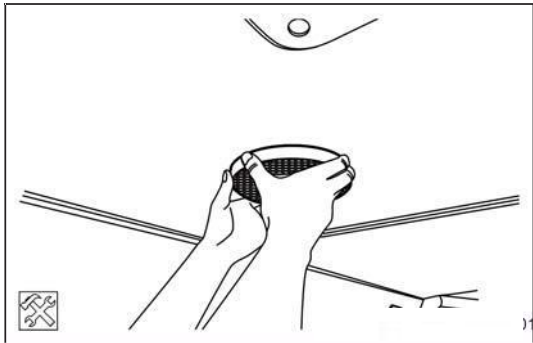

1.
(a).

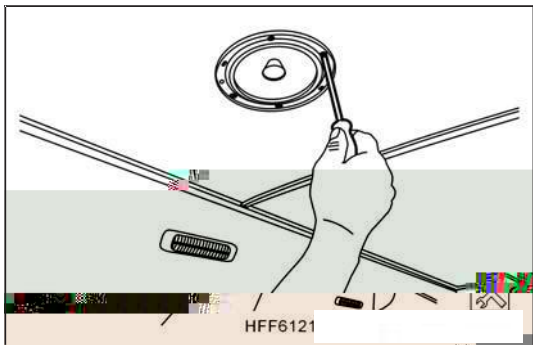

(b).

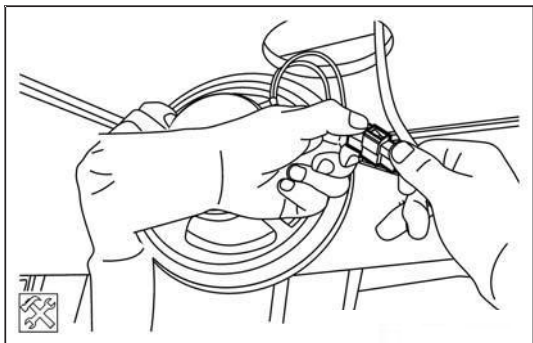

(c).
(d).

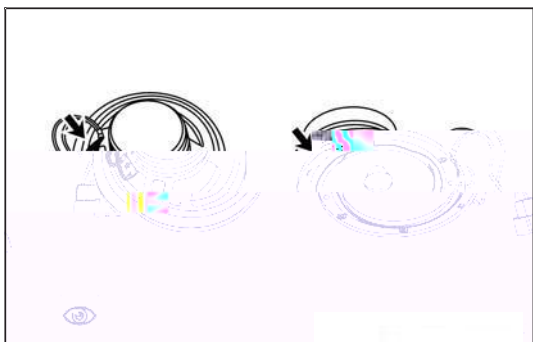

2.
(a).

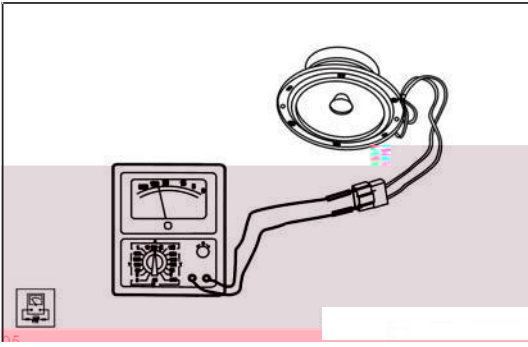

(b).

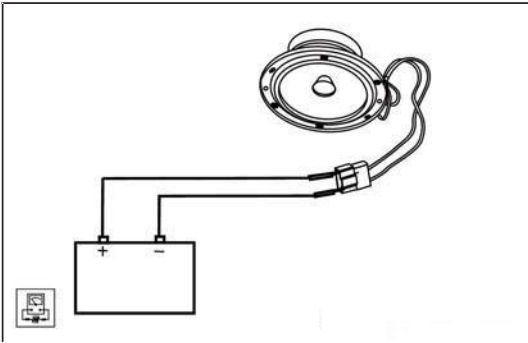

(c). 12 V

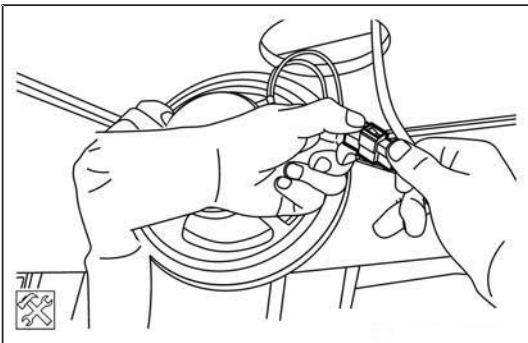

3.
(a).



(b).

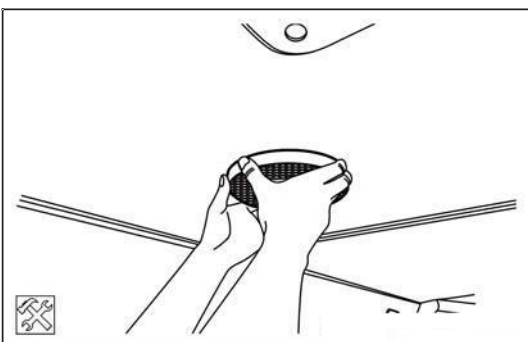

(c).



1.
(a).

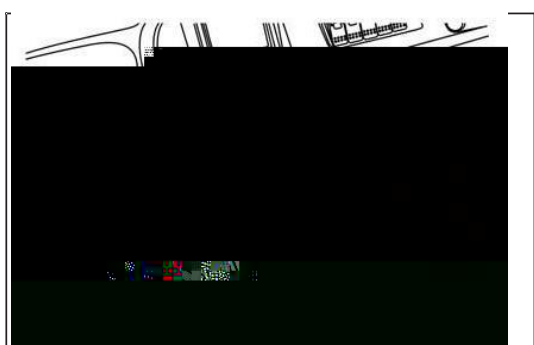

(b).

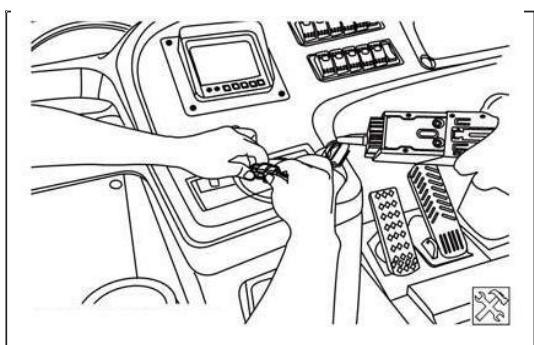

(c).



(d).

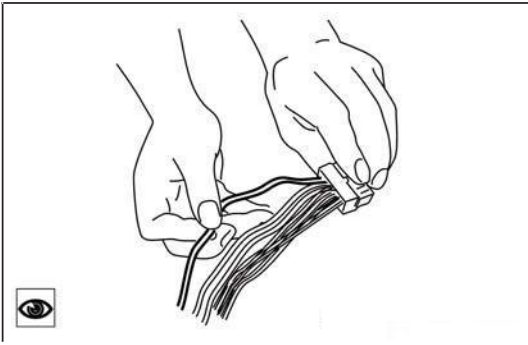

2.
(a).

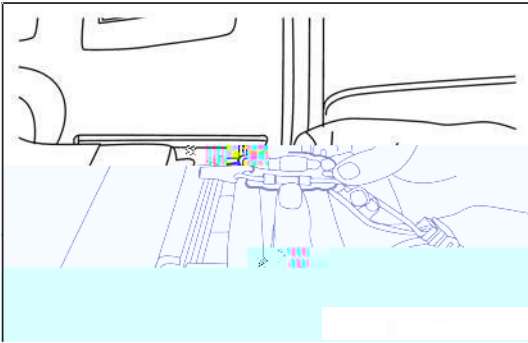

(b).

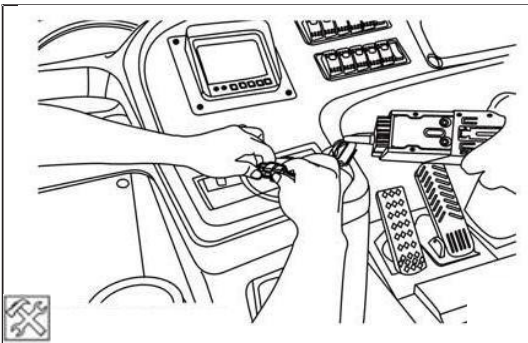

3.
(a).

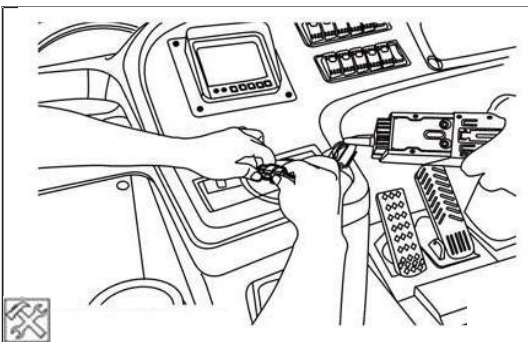

(b).

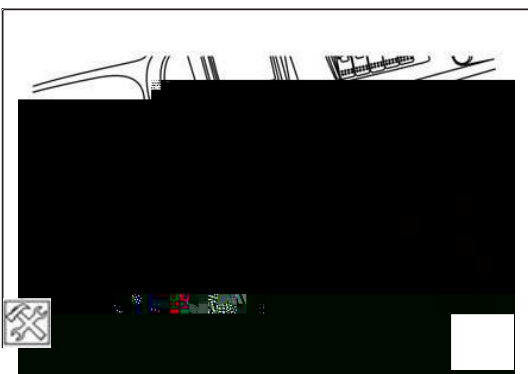

(c).



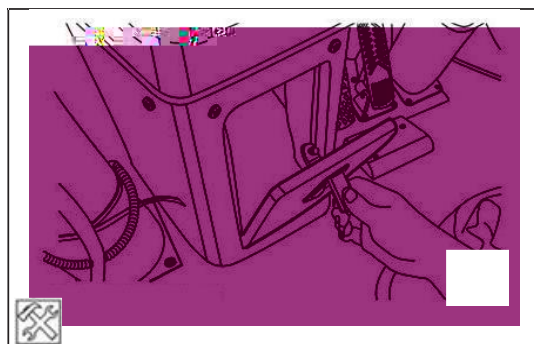

(d).

1. 76 / -

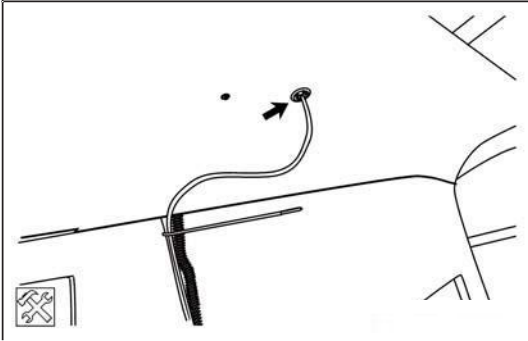

2.
(a).

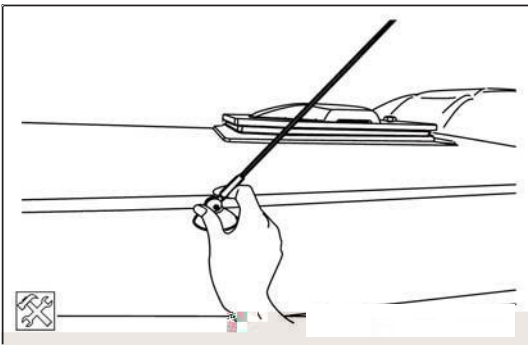

(b).

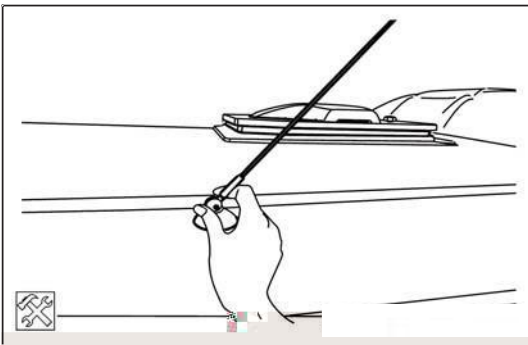

3.
(a).

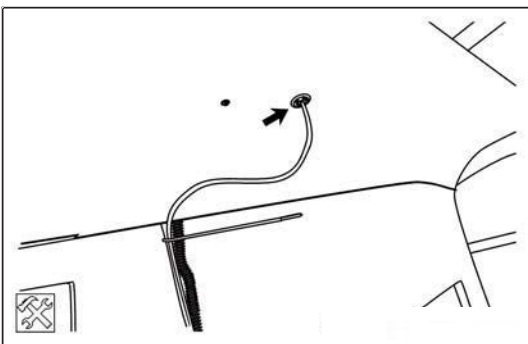

(b).

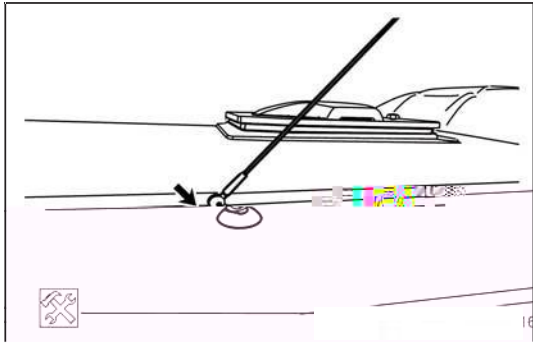

(c).

4.

76 /

- -
